

New Fuzzy Modelisation and Control Strategy of Random Disturbances

K. Jemai*, H. Trabelsi

Received: 20 April 2013;

Accepted: 5 August 2013

Abstract The guaranty of power system stability during random disturbance requires systematically a wide knowledge of the disturbance components in one hand and their range of variation in the other hand. The major problem lies in the approach taken to the identification of the main components of this type of disturbances. Control strategy will only be effective if these disturbances are acceptably modeled.

Keywords Random Disturbance, Power System, Fuzzy Logic, Positive Synchronous Reference Frame (PSRF), Negative Synchronous Reference Frame (NSRF).

1 Introduction

Taking into account the complexity of their topology and by a growing demand for energy on the other hand, power systems have in recent decades a considerable weakening on their ability to withstand the adverse effects of disturbances [1]. These operating conditions are becoming increasingly unfavourable especially when the power system will be solicited by random events. Studies of these situations are generally tilted to the implementation of control algorithms while considering that these disturbances are previously identified.

Indeed, during the test campaigns, researchers are committed to the study and implementation of control strategies taking into account disturbances whose basic components are previously set by the knowledge of the amplitude, time latching and duration are set in advance. These test conditions suggest serious difficulties in case the studied power system is subjected to a disturbance whose basic components mentioned become with random characters. And therefore, we can not in any circumstances identify the dynamic behaviour of the system during the time of occurrence of this type of disturbance [2, 3].

In this paper we focused on the implementation of a new strategy for intelligent control of a power system subject to random disturbances. Indeed, the switching time, the amplitude and the duration thereof are not known in advance. Fuzzy controllers assess the impact of three basic components of each state variable of the system under consideration, and a decision will

* Corresponding Author. (✉)

E-mail: jemaissatgb@yahoo.fr (K. Jemai)

K. Jemai

Professor, Department of Electromechanical Engineering at the High Institute of Applied Sciences and Technology, ISSAT-Gabès 6072, Tunisia.

H. Trabelsi

Professor, National School of Engineers of Sfax, ENIS, Tunisia, and a member of the Computer, Electronics, & Smart engineering systems design «CES» research team, Sfax, Tunisia.

be made by the intelligent strategy to assign greater stability in the power system during the onset phase of random perturbation [5], [6].

2 The fuzzy studied model

The topology of each fuzzy controller to integrate was based on an interaction between two input variables, characterized successively by an error \mathcal{E}_x and an instantaneous variation of the error $\frac{\partial \mathcal{E}_x}{\partial t}$, to synthesize a control vector U_f acting on one of the state variables of the processes studied.

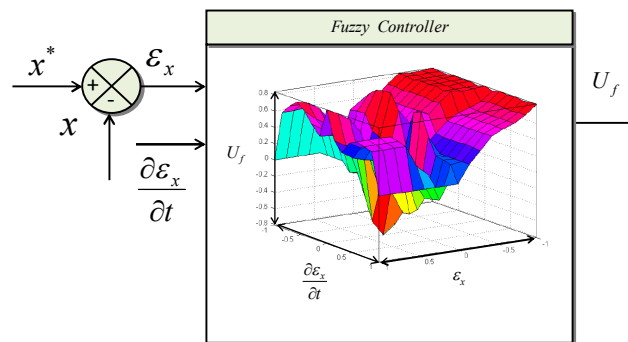

Fig. 1 The fuzzy controller Model

Indeed, we have implemented the matrix of fuzzy inference through a number of membership functions MF_i , as well for error \mathcal{E}_x , for the variation of the error $\frac{\partial \mathcal{E}_x}{\partial t}$ and for the control vector U_f , equal to 1. Thus, the total number of fuzzy inferences $N_{règles}$ amounted to 121, table 1, attributing accordingly greater accuracy to the decision taken by the specified controller [7], [8].

Table 1 Membership functions

1	$MF_1 \Rightarrow MF_{NVL}$
2	$MF_2 \Rightarrow MF_{NL}$
3	$MF_3 \Rightarrow MF_N$
4	$MF_4 \Rightarrow MF_{NM}$
5	$MF_5 \Rightarrow MF_{NS}$
6	$MF_6 \Rightarrow MF_{ZE}$
7	$MF_7 \Rightarrow MF_{PS}$
8	$MF_8 \Rightarrow MF_{PM}$
9	$MF_9 \Rightarrow MF_P$
10	$MF_{10} \Rightarrow MF_{PL}$
11	$MF_{11} \Rightarrow MF_{PVL}$

Where:

NVL : Negative Very Large, *NL* : Negative Large, *N* : Negative, *NM* : Negative Medium, *NS* : Negative Small, *ZE* : Zero, *PS* : Positive Small, *PM* : Positive Medium, *P* : Positive, *PL* : Positive Large, *PVL* : Positive very Large.

We defined the degree of membership of the error \mathcal{E}_x to a membership function MF_n par

$\mu^\epsilon(\mathcal{E}_x) \Big|_{MF_n}$ and $\mu^\epsilon\left(\frac{\partial \mathcal{E}_x}{\partial t}\right) \Big|_{MF_n}$ the degree of membership of the error variation to a membership function MF_n , figure 2.

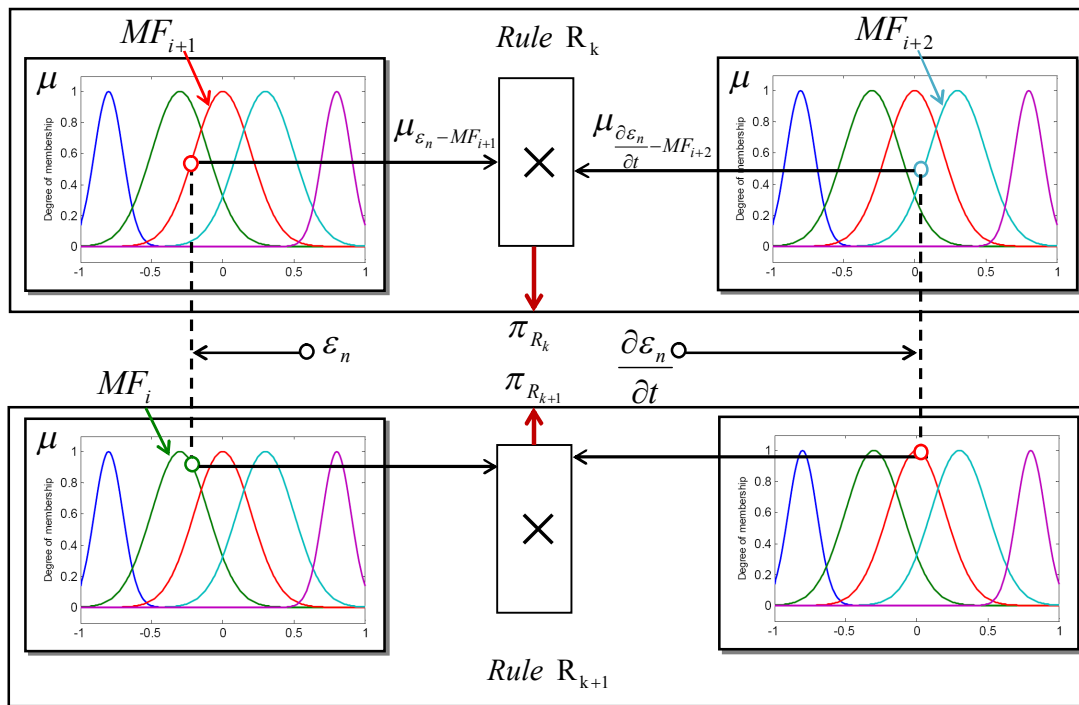

Fig. 2 Rules treatment

While referring to figure 2, we write:

$$\pi_{R_k} = \mu^\epsilon(\mathcal{E}_x) \Big|_{MF_n(\mathcal{E}_x)} \cdot \mu^\epsilon\left(\frac{\partial \mathcal{E}_x}{\partial t}\right) \Big|_{MF_n\left(\frac{\partial \mathcal{E}_x}{\partial t}\right)} \tag{1}$$

Also,

$$\pi_{R_{k+1}} = \mu^\epsilon(\mathcal{E}_x) \Big|_{MF_{n+1}(\mathcal{E}_x)} \cdot \mu^\epsilon\left(\frac{\partial \mathcal{E}_x}{\partial t}\right) \Big|_{MF_{n+1}\left(\frac{\partial \mathcal{E}_x}{\partial t}\right)} \tag{2}$$

A surface S_{R_k} swept by the control vector U_f for a rule R_k is given by:

$$\begin{cases} S_{R_k} = \pi_{R_k} . MF_n(U_f) \\ S_{R_k} = \mu^\varepsilon(\varepsilon_x) \Big|_{MF_{n+1}(\varepsilon_x)} \cdot \mu^\varepsilon\left(\frac{\partial \varepsilon_x}{\partial t}\right) \Big|_{MF_{n+1}\left(\frac{\partial \varepsilon_x}{\partial t}\right)} . MF_n(U_f) \end{cases} \quad (3)$$

The overall surface swept by the control vector U_f after the use of all rules is formulated as follows:

$$S_{U_f} = \frac{\sum_{k=1}^{N_{R_k}} S_{R_k}}{N_{R_k}} \quad (4)$$

with N_{R_k} as the number of rules used. Thus, the unfuzzy vector U_{NF} is none other than the abscissa of the center of gravity of the overall surface S_{U_f} swept by the control vector U_f is deduced in accordance with the relationship:

$$\begin{cases} U_{NF} = \frac{\int_{-1}^1 \pi_{R_k} . MF_n(U_f) . U_f . dU_f}{\int_{-1}^1 \pi_{R_k} . MF_n(U_f) . dU_f} \\ U_{NF} = \frac{\int_{-1}^1 \mu^\varepsilon(\varepsilon_x) \Big|_{MF_{n+1}(\varepsilon_x)} \cdot \mu^\varepsilon\left(\frac{\partial \varepsilon_x}{\partial t}\right) \Big|_{MF_{n+1}\left(\frac{\partial \varepsilon_x}{\partial t}\right)} . MF_n(U_f) . U_f . dU_f}{\int_{-1}^1 \mu^\varepsilon(\varepsilon_x) \Big|_{MF_{n+1}(\varepsilon_x)} \cdot \mu^\varepsilon\left(\frac{\partial \varepsilon_x}{\partial t}\right) \Big|_{MF_{n+1}\left(\frac{\partial \varepsilon_x}{\partial t}\right)} . MF_n(U_f) . dU_f} \end{cases} \quad (5)$$

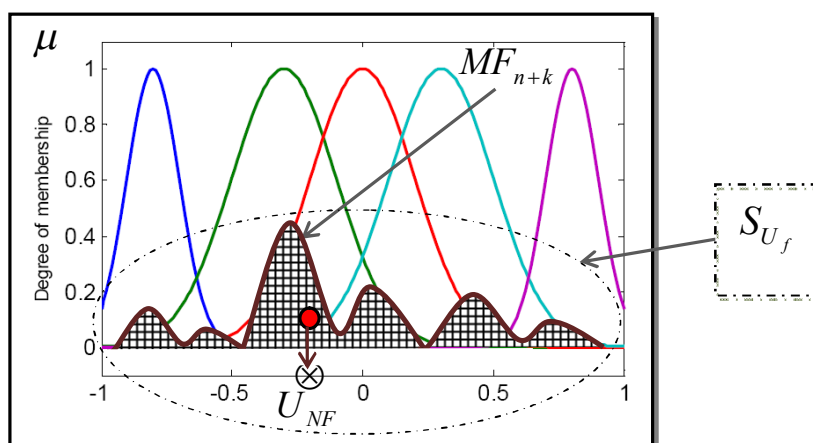

Fig. 3 Fuzzy control evaluation

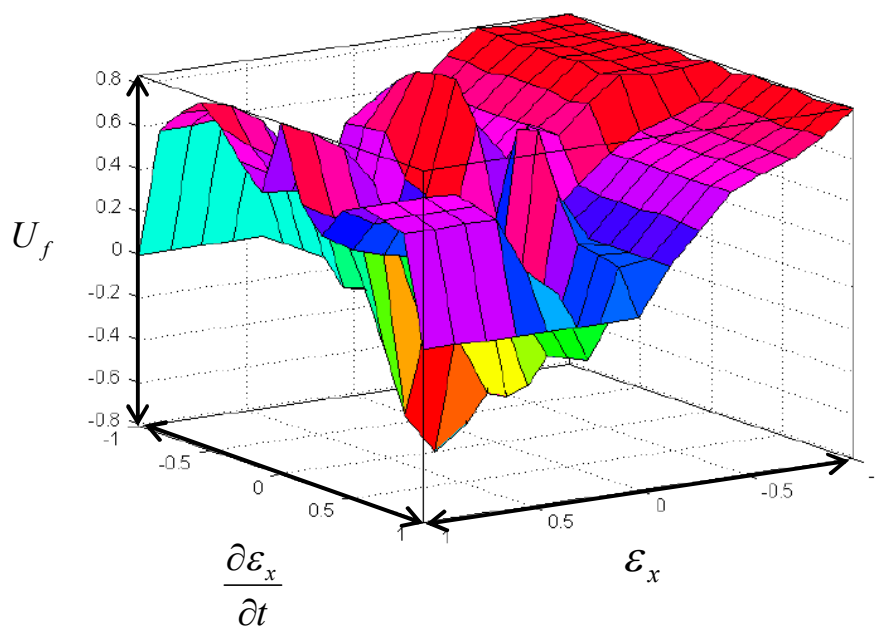

Fig. 4 Surface swept by a fuzzy vector

3 A new rescaling technique

A new technique of scaling will be of great importance for the magnitudes of the state variables that may possibly exceed the extreme limits quoted. In other words, all sizes to be treated as X_i giving rise to an error $\varepsilon_i(t)$ and a variation of error $\frac{\partial \varepsilon_i(t)}{\partial t}$, must undergo a transfer at the base of fuzzy variables evidenced by the interval $[-1, 1]$, to generate the fuzzy input

$[\varepsilon_x(t)$ and $\frac{\partial \varepsilon_x(t)}{\partial t}$] required for processing by the designated controller in accordance with the following system of equations:

$$\begin{cases} \varepsilon_x = K_{\varepsilon_i} \cdot \varepsilon_i(t) + [1 - K_{\varepsilon_i}] \\ \frac{\partial \varepsilon_x}{\partial t} = K_{\frac{\partial \varepsilon_i}{\partial t}} \cdot \frac{\partial \varepsilon_i(t)}{\partial t} + [1 - K_{\frac{\partial \varepsilon_i}{\partial t}}] \\ K_{\varepsilon_i} = \frac{2}{G_{\max}^{ss}(MF_n |_{\varepsilon_i}) - G_{\min}^{ss}(MF_n |_{\varepsilon_i})} \\ K_{\frac{\partial \varepsilon_i}{\partial t}} = \frac{2}{G_{\max}^{ss}(MF_n |_{\frac{\partial \varepsilon_i}{\partial t}}) - G_{\min}^{ss}(MF_n |_{\frac{\partial \varepsilon_i}{\partial t}})} \end{cases} \quad (6)$$

Where:

$$\begin{cases} G_{\max}^{ss}(MF_n |_{\varepsilon_i}) = \text{Max} \left[\frac{1}{\sigma_{\varepsilon_i} \cdot \sqrt{2\pi}} \cdot \exp \left[-\frac{(\varepsilon_i - \mu_{\varepsilon_i})^2}{2\sigma_{\varepsilon_i}^2} \right] \right] \\ G_{\min}^{ss}(MF_n |_{\varepsilon_i}) = \text{Min} \left[\frac{1}{\sigma_{\varepsilon_i} \cdot \sqrt{2\pi}} \cdot \exp \left[-\frac{(\varepsilon_i - \mu_{\varepsilon_i})^2}{2\sigma_{\varepsilon_i}^2} \right] \right] \\ G_{\max}^{ss}(MF_n |_{\frac{\partial \varepsilon_i}{\partial t}}) = \text{Max} \left[\frac{1}{\sigma_{\frac{\partial \varepsilon_i}{\partial t}} \cdot \sqrt{2\pi}} \cdot \exp \left[-\frac{\left(\frac{\partial \varepsilon_i}{\partial t} - \mu_{\frac{\partial \varepsilon_i}{\partial t}}\right)^2}{2\sigma_{\frac{\partial \varepsilon_i}{\partial t}}^2} \right] \right] \\ G_{\min}^{ss}(MF_n |_{\frac{\partial \varepsilon_i}{\partial t}}) = \text{Min} \left[\frac{1}{\sigma_{\frac{\partial \varepsilon_i}{\partial t}} \cdot \sqrt{2\pi}} \cdot \exp \left[-\frac{\left(\frac{\partial \varepsilon_i}{\partial t} - \mu_{\frac{\partial \varepsilon_i}{\partial t}}\right)^2}{2\sigma_{\frac{\partial \varepsilon_i}{\partial t}}^2} \right] \right] \end{cases}$$

Where μ_i , σ_i denote respectively the mean and standard deviation of the error and variation of error ε_i and $\frac{\partial \varepsilon_i}{\partial t}$. Similarly, the control vector U_{NF} must undergo a transfer to the basic quantities studied (per unit), rescaled, to assign the value U_{NF}^{res} and this means the system of equations:

$$\begin{cases} U_{NF}^{res} = K_{U_{NF}^{res}} U_{NF} + [1 - K_{U_{NF}^{res}}] \\ K_{U_{NF}^{res}} = \frac{G_{\max}^{ss}(MF_n(U_f)) - G_{\min}^{ss}(MF_n(U_f))}{2} \end{cases} \quad (7)$$

Where:

$$\begin{cases} G_{Max}^{ss}(MF_n(U_f)) = Max \left[\frac{1}{\sigma_{U_f} \cdot \sqrt{2\pi}} \cdot \exp \left[-\frac{(U_f - \mu_{U_f})^2}{2\sigma_{U_f}^2} \right] \right] \\ G_{Min}^{ss}(MF_n(U_f)) = Min \left[\frac{1}{\sigma_{U_f} \cdot \sqrt{2\pi}} \cdot \exp \left[-\frac{(U_f - \mu_{U_f})^2}{2\sigma_{U_f}^2} \right] \right] \end{cases}$$

Through this new technique of rescaling, we assigned a dynamic behavior to the fuzzy controller in order to ensure better tracking of the variable to control.

4 The random disturbance model

Usually, in the done works, the researchers deal with disturbances as defined variables. Indeed, during simulations of a power system behaviour with respect to certain disturbances (*randis*), time of occurrence t_{dis} , duration d_{dis} and magnitude m_{dis} of these disturbances are previously known [11].

$$randis = F_{dis}^{rand}(t_{dis}, d_{dis}, m_{dis}) \quad (8)$$

For a given state model,

$$[\dot{X}] = [A].[X] + [B].[U] \quad (9)$$

With:

$$[\dot{X}] = [\dot{x}_1 \quad \dot{x}_2 \dots \quad \dot{x}_{n-1} \quad \dot{x}_n]^T ; \text{ a state vector,}$$

$$[A] = \begin{bmatrix} a_{11} & a_{12} \dots & a_{1c} \\ a_{21} & a_{22} \dots & a_{2c} \\ a_{n1} & a_{n2} \dots & a_{nc} \end{bmatrix},$$

$$[B] = [b_1 \quad b_2 \dots \quad b_{n-1} \quad b_n]^T ,$$

$$[U] = [u_1 \quad u_2 \dots \quad u_{n-1} \quad u_n]^T , \text{ a control vector.}$$

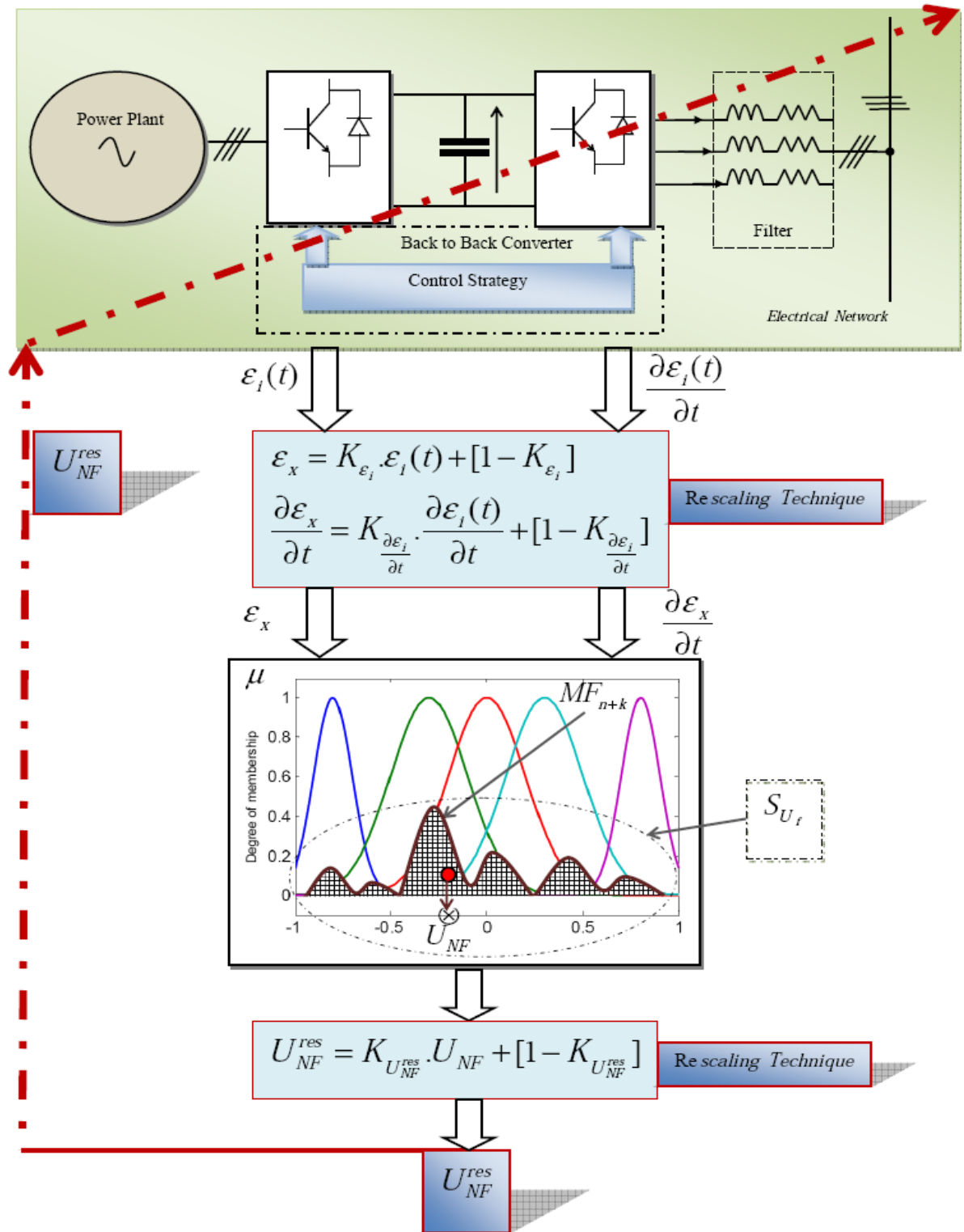

Fig. 5 Rescaling flowchart

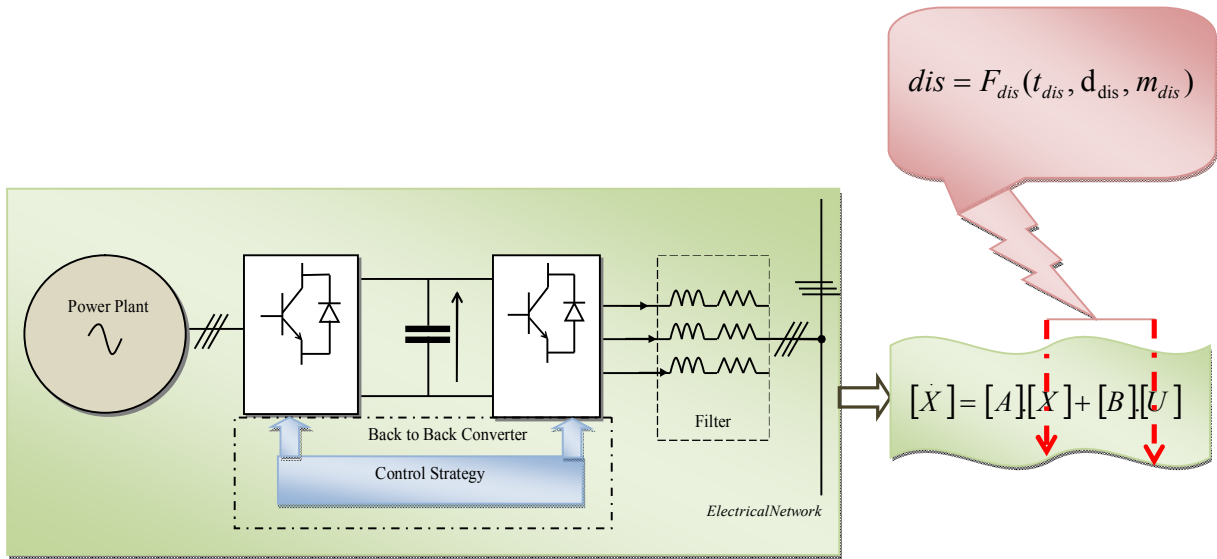

Fig. 6 Model of study

Taking into account the fact that we deal with different variables on two synchronous references (PSRF and NSRF), figure 7, and during a certain disturbance, the vector $[X]$ will have new superimposed components .

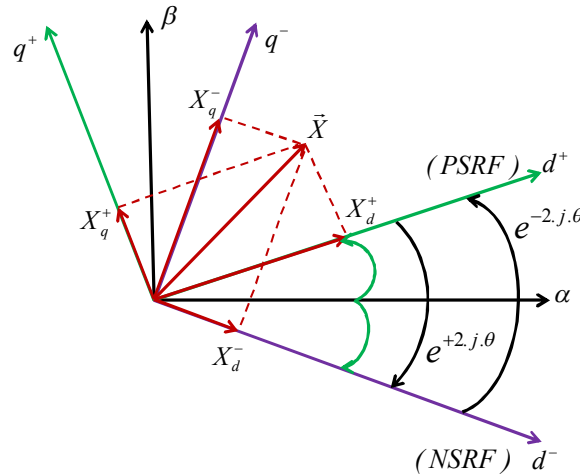

Fig. 7 References of study

Where $\theta = 2.\pi.f.t$ and f is the frequency.

Relating to figure 7 and according to Park (d, q) voltage and/or currents components, we establish the following relations.

$$\begin{bmatrix} x_{dk}^{PSRF} \\ x_{qk}^{PSRF} \end{bmatrix} = \begin{bmatrix} x_{dkp}^{PSRF} \\ x_{qkp}^{PSRF} \end{bmatrix} + \begin{bmatrix} \cos(2.\theta_s) & \sin(2.\theta_s) \\ -\sin(2.\theta_s) & \cos(2.\theta_s) \end{bmatrix} \cdot \begin{bmatrix} x_{dkn}^{NSRF} \\ x_{qkn}^{NSRF} \end{bmatrix} \quad (10)$$

With: $k = \{1, \dots, n\}$.

$$\begin{cases} x_{dk}^{PSRF} = x_{dkp}^{PSRF} + x_{dk}^{PSRF} (2f) \\ x_{qk}^{PSRF} = x_{qkp}^{PSRF} + x_{qk}^{PSRF} (2f) \end{cases} \quad (11)$$

Otherwise:
And:

$$\begin{cases} u_{dk}^{PSRF} = u_{dkp}^{PSRF} + u_{dk}^{PSRF} (2f) \\ u_{qk}^{PSRF} = u_{qkp}^{PSRF} + u_{qk}^{PSRF} (2f) \end{cases} \quad (12)$$

The dynamic behavior analysis of the studied power system is based on a relevant modeling taking into account the electrodynamic possible states affecting the network in case of serious event appearances [6].

In fact, in this paper we have adopted a random disturbance mainly characterized by three components, time of emergence t_{dis} , duration d_{dis} and the magnitude m_{dis} . Consequently, the impact of these components is materialized by a random function F_{dis}^{rand} which will be evaluated by using a fuzzy estimation topology.

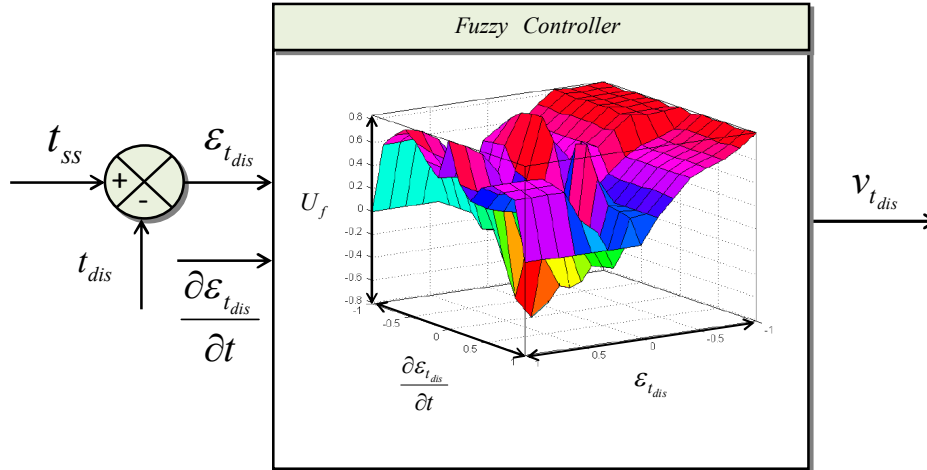

Fig. 8 Evaluation of the effect of time emergence of the random disturbance

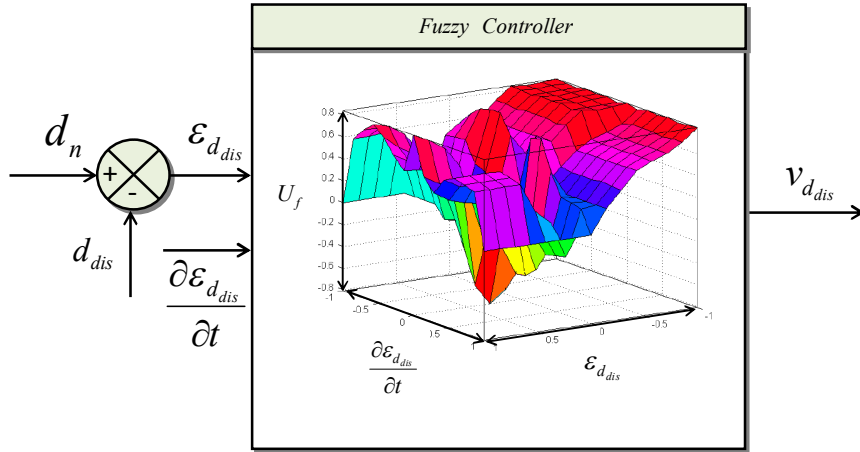

Fig. 9 Evaluation of the effect of the duration of the random disturbance

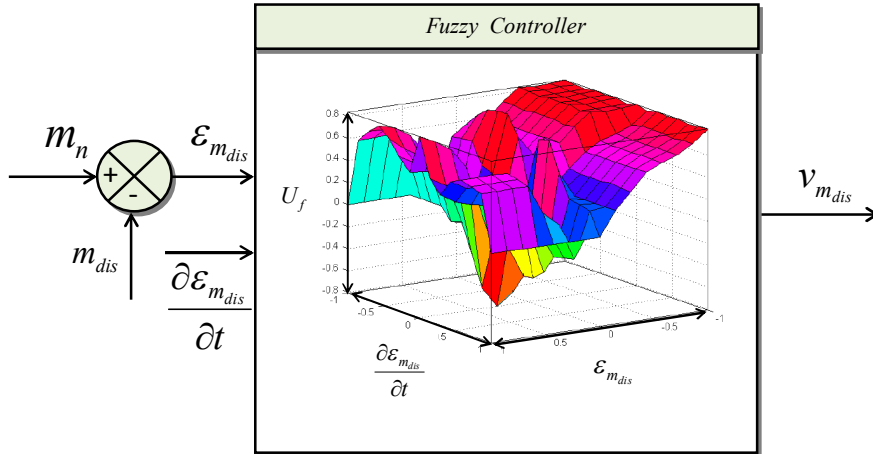

Fig. 10 Evaluation of the effect of the magnitude of the random disturbance

By referring to the topology indicated by figures 8, 9 and 10, we define a resultant random control vector V_{dis}^{rand} as follows:

$$V_{dis}^{rand} = v_{t_{dis}} + v_{d_{dis}} + v_{m_{dis}} \tag{13}$$

Then, Having considered the amplitudes of state variables before the appearance of random disturbance:

$$\begin{cases} x_1^{PSRF} = a_{11}x_1^{PSRF} + a_{12}x_2^{PSRF} + \dots + a_{1n}x_n^{PSRF} + b_{11}u_1^{PSRF} + b_{12}u_2^{PSRF} + \dots + b_{1n}u_n^{PSRF} \\ x_2^{PSRF} = a_{21}x_1^{PSRF} + a_{22}x_2^{PSRF} + \dots + a_{2n}x_n^{PSRF} + b_{21}u_1^{PSRF} + b_{22}u_2^{PSRF} + \dots + b_{2n}u_n^{PSRF} \\ \cdot \\ \cdot \\ \cdot \\ x_n^{PSRF} = a_{n1}x_1^{PSRF} + a_{n2}x_2^{PSRF} + \dots + a_{nn}x_n^{PSRF} + b_{n1}u_1^{PSRF} + b_{n2}u_2^{PSRF} + \dots + b_{nn}u_n^{PSRF} \end{cases} \tag{14}$$

We establish weighting coefficients to quantify the contribution of a factor a_{ij} on the dynamics of variation of a state variable x_i^{PSRF} . Similarly, we quantify the contribution of a factor b_{ij} on the dynamics of variation of a state variable u_i^{PSRF} , $i = \{1, \dots, n\}$:

$$\left\{ \begin{aligned} W_{a_{ij}}^{PSRF} &= \frac{a_{ij}}{\sum_{j=1}^{j=n} a_{ij}} \\ W_{b_{ij}}^{PSRF} &= \frac{b_{ij}}{\sum_{j=1}^{j=n} b_{ij}} \end{aligned} \right. \tag{15}$$

Under these conditions, the partial impact of the random vector resultant V_{dis}^{rand} on the dynamics of change of the state variables (x_i^{PSRF}, u_i^{PSRF}) , $i = \{1, \dots, n\}$ is evaluated as follows:

$$\left\{ \begin{aligned} V_{dis}^{rand} \Big|_{x_{ij}} &= V_{dis}^{rand} W_{a_{ij}}^{PSRF} \\ V_{dis}^{rand} \Big|_{u_{ij}} &= V_{dis}^{rand} W_{b_{ij}}^{PSRF} \end{aligned} \right. \tag{16}$$

At this level of calculation, we generate by means of fuzzy controller the coefficients $Coeff_{x_{ij}}$ knowing the state variable x_i^{PSRF} before occurrence of a random defect. This variable will be counted as a reference value denoted x_i^{*PSRF} .

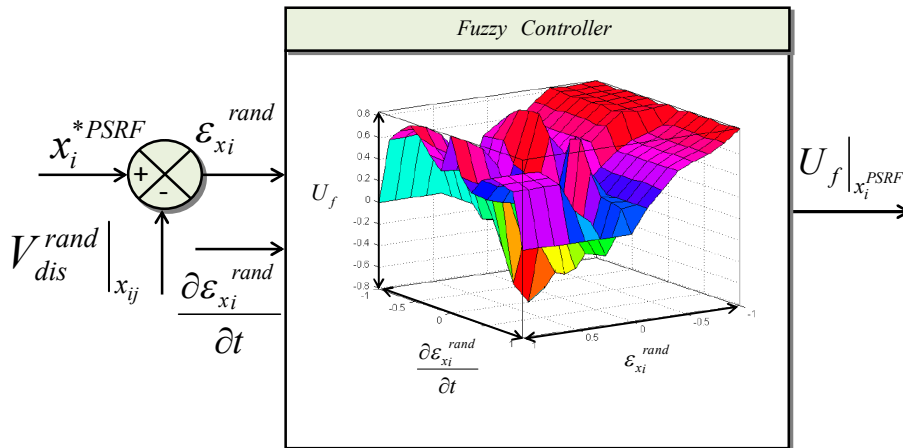

Fig. 11 Random coefficients evaluation

Thus, non-fuzzy coefficients $Coeff_{x_{ij}}$ are assessed according to the following relationship:

$$Coeff_{x_{ij}} = \frac{\int_{-1}^1 \mu^\in(\varepsilon_{x_i}^{rand}) \Big|_{MF_{n+1}(\varepsilon_{x_i}^{rand})} \cdot \mu^\in\left(\frac{\partial \varepsilon_{x_i}^{rand}}{\partial t}\right) \Big|_{MF_{n+1}\left(\frac{\partial \varepsilon_{x_i}^{rand}}{\partial t}\right)} \cdot MF_n(U_f |_{x_i^{PSRF}}) \cdot U_f |_{x_i^{PSRF}} dU_f |_{x_i^{PSRF}}}{\int_{-1}^1 \mu^\in(\varepsilon_{x_i}^{rand}) \Big|_{MF_{n+1}(\varepsilon_{x_i}^{rand})} \cdot \mu^\in\left(\frac{\partial \varepsilon_{x_i}^{rand}}{\partial t}\right) \Big|_{MF_{n+1}\left(\frac{\partial \varepsilon_{x_i}^{rand}}{\partial t}\right)} \cdot MF_n(U_f |_{x_i^{PSRF}}) dU_f |_{x_i^{PSRF}}} \quad (17)$$

while:

$$\begin{cases} Coeff_{x_{ij}}^{res} = K_{Coeff_{x_{ij}}^{res}} \cdot Coeff_{x_{ij}} + [1 - K_{Coeff_{x_{ij}}^{res}}] \\ K_{Coeff_{x_{ij}}^{res}} = \frac{G_{max}^{ss}(MF_n(Coeff_{x_{ij}})) - G_{min}^{ss}(MF_n(Coeff_{x_{ij}}))}{2} \end{cases} \quad (18)$$

Similarly, the coefficients $Coeff_{u_{ij}}$ will be evaluated according to the following diagram:

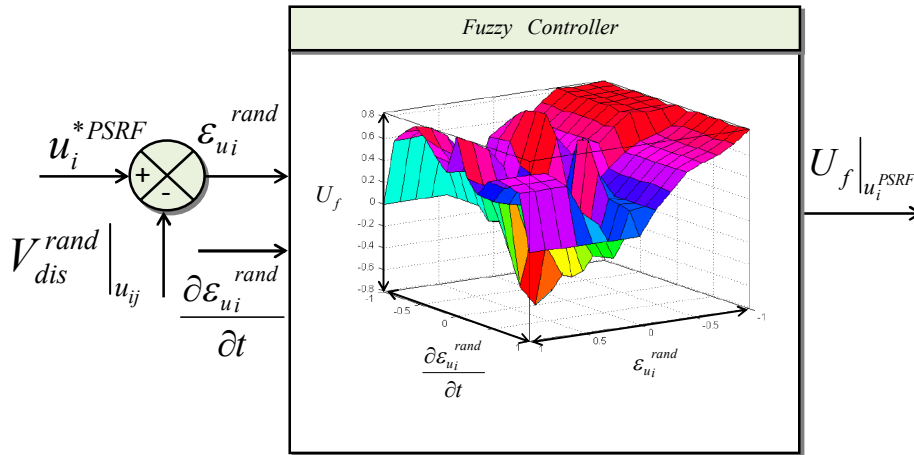

Fig. 12 Surface swept by a fuzzy vector

with:

$$Coeff_{u_{ij}} = \frac{\int_{-1}^1 \mu^\in(\varepsilon_{u_i}^{rand}) \Big|_{MF_{n+1}(\varepsilon_{u_i}^{rand})} \cdot \mu^\in\left(\frac{\partial \varepsilon_{u_i}^{rand}}{\partial t}\right) \Big|_{MF_{n+1}\left(\frac{\partial \varepsilon_{u_i}^{rand}}{\partial t}\right)} \cdot MF_n(U_f |_{u_i^{PSRF}}) \cdot U_f |_{u_i^{PSRF}} dU_f |_{u_i^{PSRF}}}{\int_{-1}^1 \mu^\in(\varepsilon_{u_i}^{rand}) \Big|_{MF_{n+1}(\varepsilon_{u_i}^{rand})} \cdot \mu^\in\left(\frac{\partial \varepsilon_{u_i}^{rand}}{\partial t}\right) \Big|_{MF_{n+1}\left(\frac{\partial \varepsilon_{u_i}^{rand}}{\partial t}\right)} \cdot MF_n(U_f |_{u_i^{PSRF}}) dU_f |_{u_i^{PSRF}}} \quad (19)$$

and:

$$\begin{cases} Coeff_{u_{ij}}^{res} = K_{Coeff_{u_{ij}}^{res}} \cdot Coeff_{u_{ij}} + [1 - K_{Coeff_{u_{ij}}^{res}}] \\ K_{Coeff_{u_{ij}}^{res}} = \frac{G_{max}^{ss}(MF_n(Coeff_{u_{ij}})) - G_{min}^{ss}(MF_n(Coeff_{u_{ij}}))}{2} \end{cases} \quad (20)$$

Therefore, the state model of a power system subjected to a random nature disturbance is

implemented based on the various coefficients established above is then:

$$\begin{cases} \dot{x}_1^{PSRF} = a_{11}.Coeff_{x_{11}}^{res} x_1^{PSRF} + \dots + a_{1n}.Coeff_{x_{1n}}^{res} x_n^{PSRF} + b_{11}.Coeff_{u_{11}}^{res} u_1^{PSRF} + \dots + b_{1n}.Coeff_{u_{1n}}^{res} u_n^{PSRF} \\ \dot{x}_n^{PSRF} = a_{n1}.Coeff_{x_{n1}}^{res} x_1^{PSRF} + \dots + a_{nn}.Coeff_{x_{nn}}^{res} x_n^{PSRF} + b_{n1}.Coeff_{u_{n1}}^{res} u_1^{PSRF} + \dots + b_{nn}.Coeff_{u_{nn}}^{res} u_n^{PSRF} \end{cases} \quad (21)$$

Consequently:

$$\begin{cases} \dot{x}_1^{PSRF} = \sum_{k=1}^{k=n} a_{1k}.Coeff_{x_{1k}}^{res} x_k^{PSRF} + \sum_{k=1}^{k=n} b_{1k}.Coeff_{u_{1k}}^{res} u_k^{PSRF} \\ \dot{x}_n^{PSRF} = \sum_{k=1}^{k=n} a_{nk}.Coeff_{x_{nk}}^{res} x_k^{PSRF} + \sum_{k=1}^{k=n} b_{nk}.Coeff_{u_{nk}}^{res} u_k^{PSRF} \end{cases} \quad (22)$$

At this moment, we will be obliged to implement an intelligent strategy, reinforced by a dynamic behaviour aiming to monitor and supervise the range escalation of each state variable x_n^{PSRF} .

5 An intelligent control strategy

The contribution of the intelligent strategy, based on fuzzy controllers, will be sensed by the dynamique variables $Coeff_{x_{ij}}^{res} x_i^{PSRF}$ and $Coeff_{u_{ij}}^{res} u_i^{PSRF}$ of the disturbed power system, figures 13 and 14.

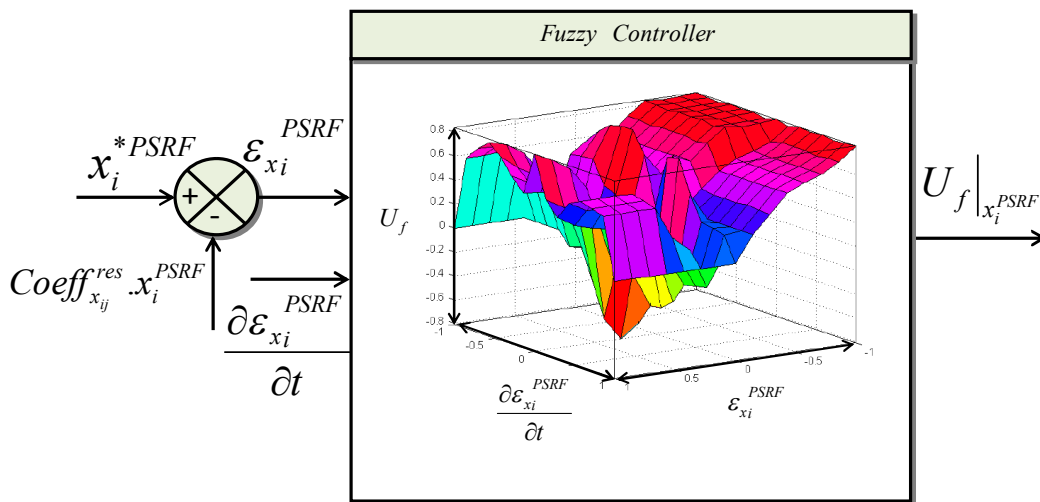

Fig. 13 Principle of the new fuzzy control strategy applied to x_i^{PSRF}

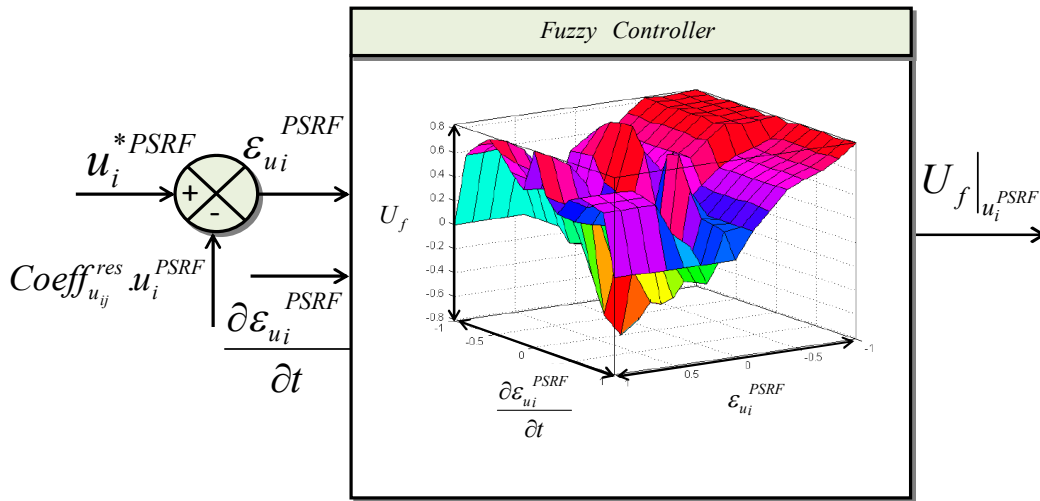

Fig. 14 Principle of the new fuzzy control strategy applied to u_i^{PSRF}

Where :

- x_k^{*PSRF} is a reference component value, of the state vector, considered before the random disturbance appearance.
- $U_f|_{x_i^{PSRF}}$ is a vector adjustment on the x_k^{PSRF} component, formulate by a fuzzy controller.

So:

and:

$$U_f|_{x_i^{PSRF}} = \frac{\int_{-1}^1 \mu^\epsilon(\epsilon_{x_i}^{PSRF})|_{MF_{n+1}(\epsilon_{x_i}^{PSRF})} \cdot \mu^\epsilon\left(\frac{\partial \epsilon_{x_i}^{PSRF}}{\partial t}\right)|_{MF_{n+1}\left(\frac{\partial \epsilon_{x_i}^{PSRF}}{\partial t}\right)} \cdot MF_n(U_f|_{x_i^{PSRF}}) \cdot U_f|_{x_i^{PSRF}} dU_f|_{x_i^{PSRF}}}{\int_{-1}^1 \mu^\epsilon(\epsilon_{x_i}^{PSRF})|_{MF_{n+1}(\epsilon_{x_i}^{PSRF})} \cdot \mu^\epsilon\left(\frac{\partial \epsilon_{x_i}^{PSRF}}{\partial t}\right)|_{MF_{n+1}\left(\frac{\partial \epsilon_{x_i}^{PSRF}}{\partial t}\right)} \cdot MF_n(U_f|_{x_i^{PSRF}}) dU_f|_{x_i^{PSRF}}} \quad (23)$$

$$U_f|_{u_i^{PSRF}} = \frac{\int_{-1}^1 \mu^\epsilon(\epsilon_{u_i}^{PSRF})|_{MF_{n+1}(\epsilon_{u_i}^{PSRF})} \cdot \mu^\epsilon\left(\frac{\partial \epsilon_{u_i}^{PSRF}}{\partial t}\right)|_{MF_{n+1}\left(\frac{\partial \epsilon_{u_i}^{PSRF}}{\partial t}\right)} \cdot MF_n(U_f|_{u_i^{PSRF}}) \cdot U_f|_{u_i^{PSRF}} dU_f|_{u_i^{PSRF}}}{\int_{-1}^1 \mu^\epsilon(\epsilon_{u_i}^{PSRF})|_{MF_{n+1}(\epsilon_{u_i}^{PSRF})} \cdot \mu^\epsilon\left(\frac{\partial \epsilon_{u_i}^{PSRF}}{\partial t}\right)|_{MF_{n+1}\left(\frac{\partial \epsilon_{u_i}^{PSRF}}{\partial t}\right)} \cdot MF_n(U_f|_{u_i^{PSRF}}) dU_f|_{u_i^{PSRF}}} \quad (24)$$

While obtaining the rescaled vector quantities $U_f|_{x_i^{PSRF}}^{res}$ and $U_f|_{u_i^{PSRF}}^{res}$ the randomly disturbed power system state model will be immediately stabilized, at the end of a step of calculation, according to the following numerical state model [14], [15].

$$\left\{ \begin{array}{l} \dot{x}_1^{PSRF} = \sum_{k=1}^{k=n} U_f \Big|_{x_k^{PSRF}}^{res} \cdot [a_{1k} \cdot Coeff_{x_{1k}}^{res} x_k^{PSRF}] + \sum_{k=1}^{k=n} U_f \Big|_{u_k^{PSRF}}^{res} \cdot [b_{1k} \cdot Coeff_{u_{1k}}^{res} u_k^{PSRF}] \\ \dot{x}_n^{PSRF} = \sum_{k=1}^{k=n} U_f \Big|_{x_k^{PSRF}}^{res} \cdot [a_{nk} \cdot Coeff_{x_{nk}}^{res} x_k^{PSRF}] + \sum_{k=1}^{k=n} U_f \Big|_{u_k^{PSRF}}^{res} \cdot [b_{nk} \cdot Coeff_{u_{nk}}^{res} u_k^{PSRF}] \end{array} \right. \quad (25)$$

6 Conclusions

In this work we developed a new fuzzy modelization and control strategy of random disturbances based on a perfect estimate margin of variations of state variables of a studied power system, as it is affected by such disturbances. To achieve this, we made recourse to fuzzy controllers dealing in a first phase with estimation of random disturbance components and their changes over time and a decision would be made in advance by such fuzzy controllers on the amount of components by the knowledge of the amplitude, time latching and duration. The basic idea of mathematical development with which we relied in order to create such a strategy has been focused on two major entities namely an efficient estimation of the principal components of random and a quantification of the impact of each disturbance component on the different state variables of the system studied. We are more than sure that this strategy will be extremely beneficial in terms of guarantee of better dynamic stabilization systems of power (electrical grids, back to back converters, etc. ..), and therefore we ensure a better quality of transited powers. The objectives of this work were achieved and prospects, in the same context, remain promising.

References

1. R. Faranda, (2007). Load shedding: New Proposal. IEEE Transactions On Power Systems, 22(4).
2. Subramanian, D. K., (1971). Optimum load shedding through Programming techniques. IEEE Transactions On Power Apparatus And Systems, 90(1).
3. Tomasic, T., Verbic, G., Gubina, F., (2005). Revision of the under frequency load-shedding scheme of the Slovenian power system. IEEE.
4. Parker, C. J., Morrison, I. F., Sutanto, D., (1998). Simulation of load shedding as a corrective action against voltage collapse. Electrical Power System Research, Elsevier 22. 235-241.
5. Ismail, M., Mustafa Hassan, M., (2012). Load Frequency Control Adaptation Using Artificial Intelligent Techniques for One and Two Different Areas Power System” International Journal of Control, Automation and Systems IJCAS, 1(1), 12-23.
6. Haidar, A. M. A., Mohamed, A., Hussain, A., (2010). Vulnerability control of large scale interconnected power system using neuro-fuzzy load shedding approach. Expert Systems with Applicatons, Elsevier 37. 3171-3176.
7. Girgis, A. A., Marthure, S., (2010). Application of active power sensitivity to frequency and voltage variations on load shedding. Electric Power Systems Research, Elsevier 80. 306-310.
8. Udupa, A. N., Purushothama, G. K., Parthasarathy, K., Thukaram, D., (2001). A fuzzy control for network over load alleviation. Electrical Power and Energy System, Elsevier 123. 119-128.
9. Huang, S. J., Huang, C. C., (2000). An adaptative load shedding method with time-based design for isolated power systems. Electrical Power and Energy Systems, Elsevier 22. 51-58.
10. Kundur, P., Power system stability and control. Electric power research institute, Power System Engineering Series, ISBN 0-07-035958-X, McGraw-Hill, Inc.

11. Anderson, P. M., Foued, A. A., Power System Stability and Control. IEEE Press Power Systems Engineering series, The institute of Electrical and Electronics Engineers, Inc., New York. 445 Hoes Lane, PO Box 1331 Piscataway, NJ 08855-1331.
12. Hannett, L. N., Fardanesh, B., (1994). Field Tests To Validate Hydro Turbine-Governor Model Structure And Parameters. IEEE Transactions on Power System, 9(4).
13. Castillo, O., Melin, P., Kacprzyk, J., Pedrycz, W., (2007). Type 2 Fuzzy Logic: Theory and Applications. IEEE International Conference on Granular Computing.
14. Haidar, A. M. A., Mohamed, A., Hussain, A., (2010). Vulnerability control of large scale interconnected power system using neuro-fuzzy load shedding approach. Expert Systems with Applications, 37(4), 3171–3176.
15. Castillo, O., Melin, P., Kacprzyk, J., Pedrycz, W., (2007). Type 2 Fuzzy Logic: Theory and Applications. IEEE International Conference on Granular Computing.
16. Wei, X., Joe, H., Chow, B., (2005). Fardanesh and Abdel-Aty Edris. A Dispatch Strategy for a Unified Power-Flow Controller to Maximize Voltage-Stability-Limited Power Transfer. IEEE Transactions On Power Delivery, 20(3).